

OSA 5581C GPS-SR

GPS - Synchronisation Receiver

Product Booklet

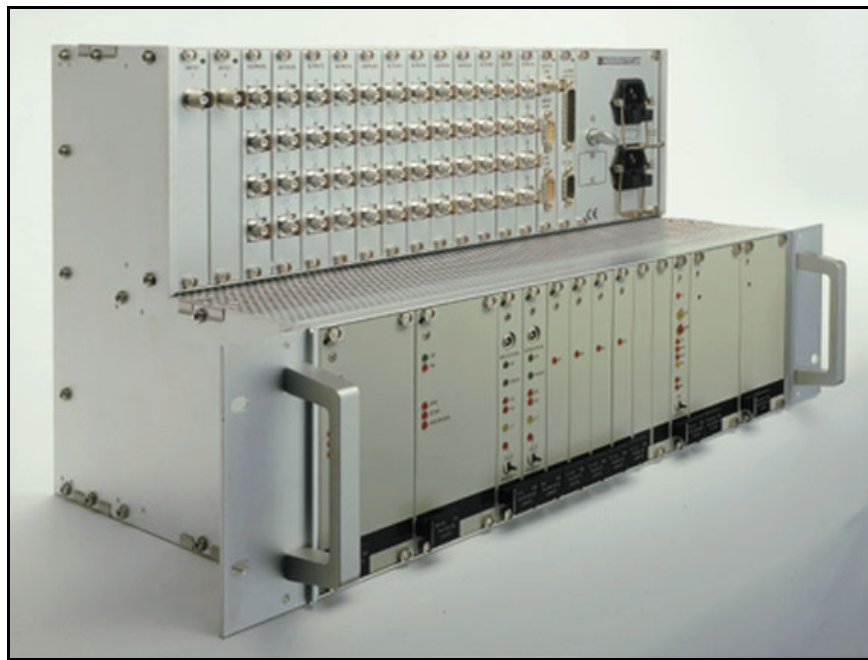

 OSCILLOQUARTZ	Author: SIPA	Pages: 2 of 35
	Title: Booklet	File: b81c_13.doc
	Distribution: External	Reference: Rev 13 31/03/2003 SIPA

Table of Contents

	Page
1 APPLICATIONS FOR THE OSA 5581C GPS-SR.....	4
2 FUNCTIONS OF THE OSA 5581C GPS-SR	5
2.1 FUNCTIONS:	5
2.2 FEATURES:	6
3 EQUIPMENT DESCRIPTION	7
3.1 EQUIPMENT LAYOUT	7
3.2 SYSTEM ARCHITECTURE	8
3.3 RELEASE FEATURES OVERVIEW	9
4 THEORY OF OPERATION.....	10
4.1 INPUT STAGE & HOLDOVER CAPABILITY	10
4.1.1 Input selection	10
4.1.2 Holdover capability	11
4.1.3 Oscillators	12
4.1.4 GPS antenna system	12
4.2 PHASE STEPPER SWITCH.....	13
4.2.1 Phase build-out	13
4.3 SYNCHRONISATION OUTPUTS	14
4.4 RE-TIMING UNIT (RTU).....	15
4.5 OUTPUT CONNECTORS.....	15
4.6 TIME CODE UNITS (TCU).....	16
4.6.1 Embedded NTP Server	16
4.6.2 IRIG-B Outputs	16
4.7 MANAGEMENT UNIT (MAC / RMU /LMU) AND CONNECTION	16
4.7.1 Remote Monitoring via Modem	16
4.8 POWER SUPPLY	17
4.9 COVER PLATES	17
4.10 CONFIGURATION.....	17
4.11 PASSIVE TIMING EXTRACTOR (TEX-P)	17
4.12 IMPEDANCE ADAPTER	18
5 RELIABILITY	19
5.1 METHOD	19
5.2 REFERENCE CONFIGURATION	19
5.3 RELIABILITY CALCULATIONS	20
6 TECHNICAL DATA	22
6.1 INPUT / HOLD-OVER SECTION	22
6.2 OUTPUT SECTION	25
6.3 MANAGEMENT SECTION	26
6.4 PHYSICAL DATA.....	28
6.5 EXTERNAL PASSIVE TIMING EXTRACTION UNIT (TEX-P).....	29
7 SUMMARY OF OSA 5581C GPS-SR PARTS.....	30
8 GLOSSARY	33
9 DOCUMENT HISTORY.....	35



 OSCILLOQUARTZ	Author: SIPA	Pages: 3 of 35
	Title: Booklet	File: b81c_13.doc
	Distribution: External	Reference: Rev 13 31/03/2003 SIPA

Table of Figures

	Page
Figure 1: Equipment layout of the OSA 5581C GPS-SR, ETSI version	7
Figure 2: Block diagram of the OSA 5581C GPS-SR.....	8
Figure 3: Block diagram of the GPS-x1-Y Input Interface Unit (IIU).	10
Figure 4: GPS antenna installation diagram.	13
Figure 5: Schematic presentation of the phase buildout.....	14
Figure 6: Block diagram of the Re-Timing Unit.	15
Figure 7: Typical use of the TEX-P with the OSA 5581C GPS-SR.....	18
Figure 8: Reliability diagram of the reference configuration.	20

Table of Tables

	Page
Table 1: Features chart for the OSA 5581C GPS-SR.....	9
Table 2: Source: ITU-T recommendation G.812 (06/98).....	11
Table 3: Minimal configuration of the OSA 5581C GPS-SR.....	17
Table 4: MTBF figures of individual modules	20
Table 5: Technical data for the input and Hold-over section.....	22
Table 6: Technical data for the output section.....	25
Table 7: Technical data for the Management Section.....	26
Table 8: Physical data for the OSA 5581C GPS-SR.....	28
Table 9: Technical data for the External Passive Timing Extraction Unit (TEX-P).....	29
Table 10: Summary of OSA 5581C GPS-SR parts.....	30
Table 11: Abbreviation used in this document.....	33
Table 12: Document history for this document.....	35

 OSCILLOQUARTZ	Author:	SIPA	Pages:	4 of 35
	Title:	Booklet	File:	b81c_13.doc
	Distribution:	External	Reference:	Rev 13 31/03/2003 SIPA

1 Applications for the OSA 5581C GPS-SR

The OSA 5581C GPS-SR is a versatile GPS receiver for all kind of synchronisation applications. Depending on the chosen configuration, it can provide framed signals, frequency & phase and/or time synchronisation signals.

Telecommunications applications examples requiring synchronisation are circuit switched network elements, SDH and SONET transport networks, and all TDMA-/CDMA-based mobile networks. In the case of circuit switched network elements and transport networks, the OSA 5581C GPS-SR can be used as a replacement for classical Primary Reference Clocks (PRC) and Synchronisation Supply Units (SSU). Each node equipped with an OSA 5581C GPS-SR gets PRC-grade synchronisation signals derived from the GPS satellites. Auxiliary electrical synchronisation input ports provide alternative references as a protection of the GPS-derived reference signal. This enables operators to adopt conceptual synchronisation planning that are different from the classical master-slave synchronisation and for isolated SDH islands. These GPS-based and mixed concepts lead to synchronisation network topologies that are simpler and easier to maintain. The OSA 5581C GPS-SR is also very useful in modern DWDM networks. It is particularly useful in cases where cell-switched or packet-switched network layers are transported directly over DWDM networks without going over SDH. In these cases there is no SDH layer that can be used for transporting synchronisation to synchronous equipment. The OSA 5581C GPS-SR is used to provide synchronisation directly where it is needed. In TDMA-based mobile networks (GSM, IS-54 D-AMPS, IS-136 D-AMPS 1900, UWC-136, etc.) the OSA 5581C GPS-SR synchronises base stations controllers and/or base stations, in order to ensure that the air interface operates with the required synchronisation stability. Sometimes SDH-based synchronisation distribution to base stations proves difficult. In such cases the OSA 5581C GPS-SR is a welcome alternative.

The OSA 5581C GPS-SR not only provides accurate and stable frequency, it is also suitable as a source of reference signals that are phase-coherent with UTC (Universal Time Co-ordinated). Many new telecommunications applications make use of phase synchronisation. The most prominent examples are CDMA-based mobile networks such as IS-95 cdmaOne, UMTS, and third generation technologies endorsed by ITU's ITM-2000 project (cdma2000 proposed by TIA, WCDMA and TD-SCDMA proposed by the 3GPP partners). These networks require the base stations to transmit frames aligned with UTC. GPS is the obvious solution. New Locations Services such as the U.S. E911 emergency call service are being defined and deployed in many kinds of mobile networks (TDMA and CDMA). These enhancements make use of the accuracy of GPS-based phase-synchronisation in the network's base stations. Similar requirements exist in digital broadcasting, namely in DVB (Digital Video Broadcasting) and DAB (Digital Audio Broadcasting) systems.

 OSCILLOQUARTZ	Author: SIPA	Pages: 5 of 35
	Title: Booklet	File: b81c_13.doc
	Distribution: External	Reference: Rev 13 31/03/2003 SIPA

2 Functions of the OSA 5581C GPS-SR

The OSA 5581C GPS-SR (GPS-Synchronisation Receiver) is a GPS receiver, accepting up to two G.703 auxiliary inputs, with holdover capability. When locked to the Global Positioning System (GPS) the OSA 5581C GPS-SR fulfils the ITU-T rec. G.811. The internal oscillators fulfil the G.812 rec.¹ whenever the GPS signal is not available.

The OSA 5581C GPS-SR is specifically designed to e.g.:

- Work as a PRC in small networks
- To be used as a high quality SSU with full SSM capability
- To supply high quality synchronisation to important end-customers
- To be installed in large and/or important nodes like MSC nodes in e.g. GPRS, 3G GSM and UMTS networks.

2.1 Functions:

The OSA 5581C GPS-SR performs the following main functions:

- Supplies ITU-T G.811 references with valid GPS signal,
- Supplies ITU-T G.812 (type I, II, V, and VI)¹ references when in holdover (without GPS signal),
- Can be equipped in single or dual GPS configuration,
- Accepts up to two back-up synchronisation reference inputs,
 - E1, T1, or frequencies,
- Monitors the status of the reference input signals (GPS and auxiliary synchronisation signal),
- Selects the best or the operator preferred sync input,
- Selects the next best or the next preferred sync input if the current has failed or fallen in quality,
- Provides automatic switching without phase jump,
- Attenuates jitter and wander on the selected synchronisation input,
- Operates as a standby reference clock in hold-over mode if all synchronisation inputs have fallen in quality or failed,
- Provides up to 64 standard telecom signal output³,
 - E1, T1, and frequencies
- Provides different output protection schemes²;
 - Up to 32 1+1 protected output signals,
 - Up to 32 1+1 protected & 32 unprotected output signals³,
 - Up to 64 unprotected output signals³,
- Provides different types of time-code outputs,
 - 1 PPS
 - Optional NTP (Network Timing Protocol),
 - Optional IRIG-B outputs
- Provides re-timing of up to 24 E1 or T1 traffic carrying signals,

¹ Fulfilment of the G.812 rec. depends on the equipped input module. Please consult Table 2, page 11, for further details.

² Do not comply with RTU module due to the protection philosophy of the traffic in the connector field.

³ 64 unprotected output signals provided with limited choice of connectors, due to physical restriction in the connector area.

	Author: SIPA	Pages: 6 of 35
	Title: Booklet	File: b81c_13.doc
	Distribution: External	Reference: Rev 13 31/03/2003 SIPA

- Supports different supervision schemes:
 - ❑ Local (on-site) management via Local Manager software
 - ❑ Remote management via Local Manager and Remote Access Manager™ software
 - ❑ Centralised via SyncView™ management application

2.2 Features:

- Available in ETSI or 19” sub-rack with single or dual power supplies,
- Wide range of output connectors,
- Choice of Rubidium or Quartz oscillators
- Partially equipped configurations available,
- Modular approach – cards can be replaced in a hot condition,
- Totally maintenance-free design.

 OSCILLOQUARTZ	Author: SIPA	Pages: 7 of 35
	Title: Booklet	File: b81c_13.doc
	Distribution: External	Reference: Rev 13 31/03/2003 SIPA

3 Equipment description

3.1 Equipment Layout

The OSA 5581C GPS-SR comes as an ETSI or 19" sub-rack. In the ETSI version the connectors are located on the front panel, while on the 19" version the connectors are located on the rear panel.

The physical layout of the OSA 5581C GPS-SR (ETSI version) is shown in Figure 1.

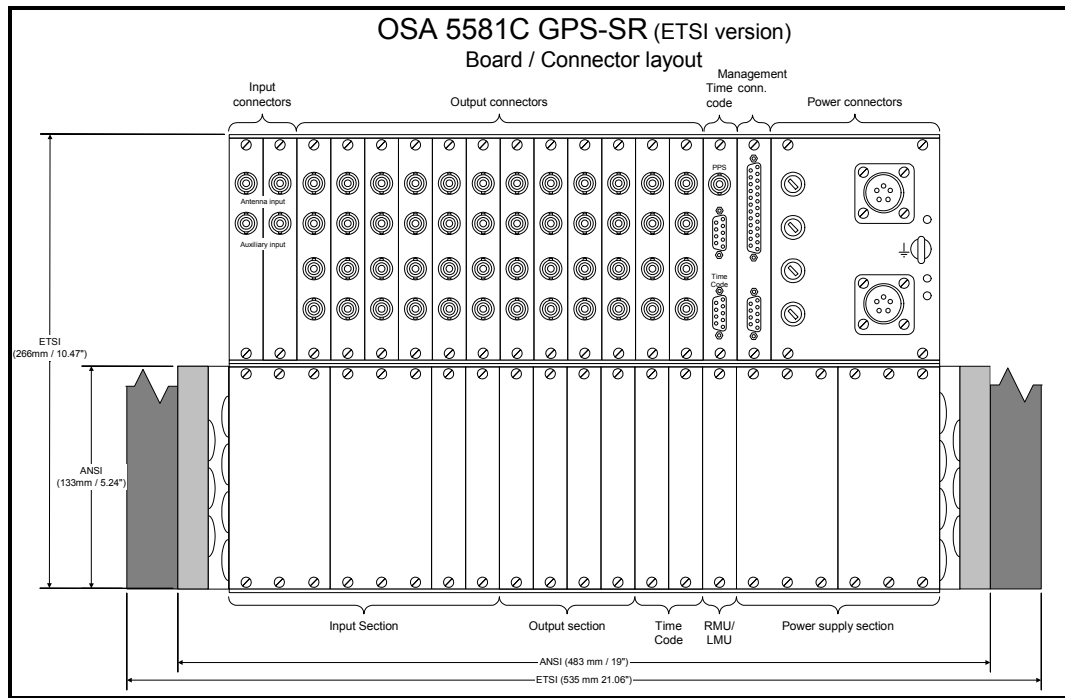



Figure 1: Equipment layout of the OSA 5581C GPS-SR, ETSI version.

The above drawing shows the maximum configuration of the equipment:

- 2 × Input & Holdover modules for GPS signal, E1 (T1) or MHz auxiliary input
- 2 × Phase Stepper Switch (PSS).
- 4 × Output Interface Unit (OIU).
- 1 × Time Code Unit (TCU) for NTP or IRIG-B time outputs.
- 1 × Management slot for Remote/Local Manager Unit (RMU/LMU)
- 2 × Power Supply Unit (PSU).
- 3 × Connector tiles Set (16 outputs each).
- 1 × Connector panel (for power supply and management).

Please refer to sections 4 and 7 for further details

 OSCILLOQUARTZ	Author: SIPA	Pages: 8 of 35
	Title: Booklet	File: b81c_13.doc
	Distribution: External	Reference: Rev 13 31/03/2003 SIPA

3.2 System architecture

Figure 2 shows the block diagram of the OSA 5581C GPS-SR.

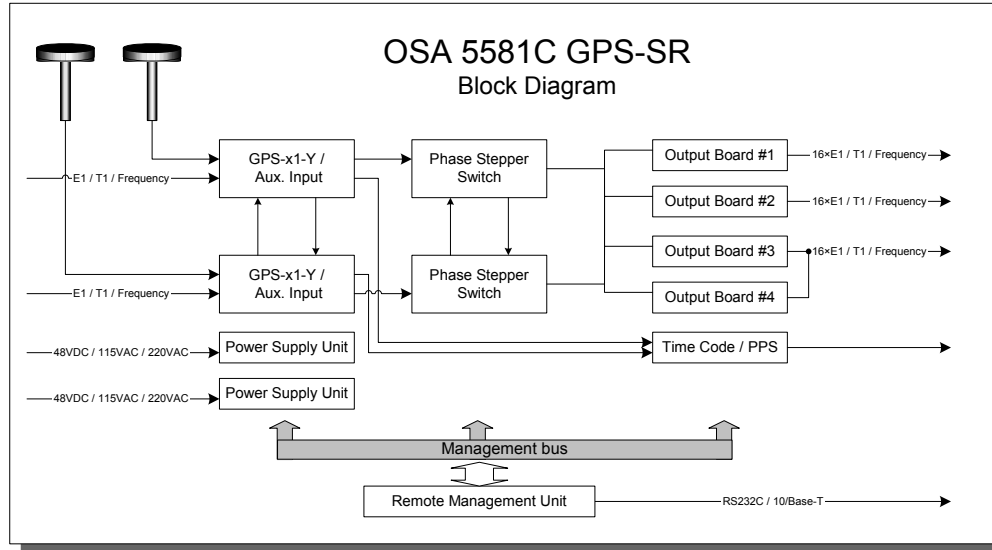



Figure 2: Block diagram of the OSA 5581C GPS-SR.

The above drawing illustrates how all the critical parts in the OSA 5581C GPS-SR are duplicated in order to obtain the highest possible reliability.

Reliability figures are given in section 5, pp. 19.

All units in the OSA 5581C GPS-SR communicate via an internal communication bus, which forms a part of the back plane. The management module, either MAC2-R, RMU or LMU, communicate with all other units via this bus.

Important: Thanks to its robust design, the OSA 5581C GPS-SR is fully operational even if the management module is faulty or removed.

 OSCILLOQUARTZ	Author:	SIPA	Pages:	9 of 35
	Title:	Booklet	File:	b81c_13.doc
	Distribution:	External	Reference:	Rev 13 31/03/2003 SIPA

3.3 Release features overview

Table 1 below lists the major features available in the different releases of the OSA 5581C GPS-SR.

Table 1: Features chart for the OSA 5581C GPS-SR.

Release	1.1	1.2	2.0E	2.1E	2.1T
G.812 type I, V, VI (SSU for SDH) oscillator	✓	✓	✓	✓	✓
G.812 type II (Stratum 2) oscillator		✓	✓	✓	✓
Auxiliary Frequency input	✓	✓	✓	✓	✓
Auxiliary E1 input	✓	✓	✓	✓	
Auxiliary T1 input	✓	✓			✓
Full SSM functionality (E1)				✓	
Full SSM functionality (T1)					✓
Manageable only locally via MAC2-R module	✓	✓			
Manageable remotely/locally via RMU/LMU			✓	✓	✓
Manageable locally via LM software	✓	✓	✓	✓	✓
Manageable remotely via LM + RAM software	✓	✓	✓	✓	✓
Manageable remotely via SyncView™			✓	✓	✓
Embedded NTP Server		✓	✓	✓	✓
Four IRIG-B outputs				✓	✓
Retiming of E1 traffic signals	✓	✓	✓	✓	
Retiming of T1 traffic signals	✓	✓			✓

 OSCILLOQUARTZ	Author: SIPA	Pages: 10 of 35
	Title: Booklet	File: b81c_13.doc
	Distribution: External	Reference: Rev 13 31/03/2003 SIPA

4 Theory of Operation

4.1 Input stage & Holdover capability

The OSA 5581C GPS-SR can be equipped with one or two GPS receivers, each with an auxiliary (E1/T1/frequency) synchronisation input.

Four types of the Input & Holdover module are available.

- GPS-E1-A
E1 / frequency auxiliary input, internal Rubidium oscillator
- GPS-T1-A
T1 / frequency auxiliary input, internal Rubidium oscillator
- GPS-E1-B
E1 / frequency auxiliary input, internal Oven-Controlled oscillator
- GPS-T1-B
T1 / frequency auxiliary input, internal Oven-Controlled oscillator

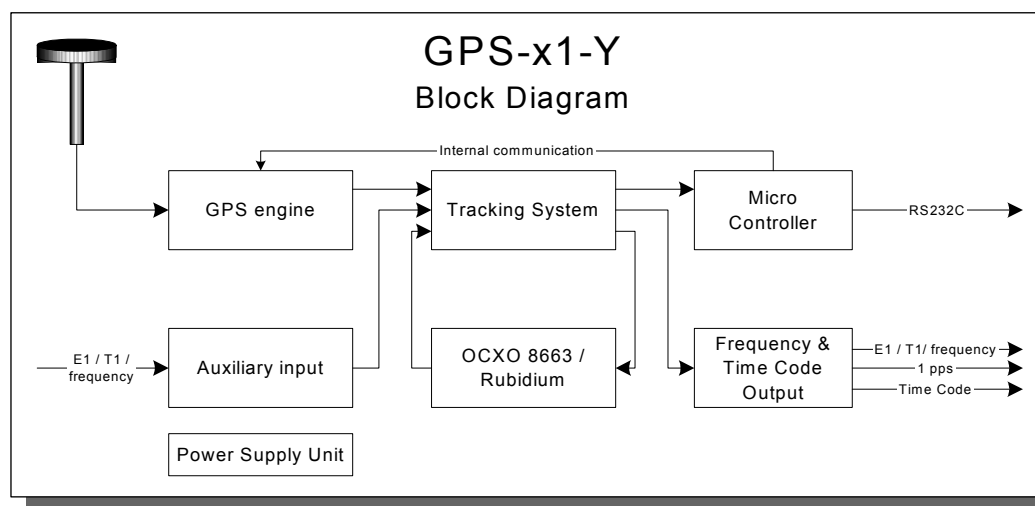

Figure 3: Block diagram of the GPS-x1-Y Input Interface Unit (IIU).

4.1.1 Input selection

The equipment selects the active sync input according to a user-defined priority table and the SSM⁴ signal if available. When input selection is based on the SSM, the input signal with the best SSM value will be selected as the reference sync input (whenever the two input signals have the same SSM value, the signal with the highest priority will be selected).

The OSA 5581C management software also allows to associate a (static) SSM value to inputs that do not carry SSM information (e.g. frequency inputs).

⁴ ITU-T rec. G.781 describes three SSM sets for lower bit rate traffic carrying signals in the SDH, SONET and Japan. Oscilloquartz have based the implementation of the SSM in the IIU on the SSM set description for SDH and SONET networks in this recommendation.

The input selection is working in a revertive mode.⁵

4.1.2 Holdover capability

The Input & Holdover module is based on the Motorola UT-Oncore GPS receiver and a holdover function provided by the internal OSA 8663 OCXO or Rubidium oscillator. These two items provide stability and filtering characteristics compliant to the ITU-T recommendation G.812 type I, II, V, and VI (i.e. they fulfil the requirements for an SSU used in a SDH and SONET network) as indicated in Table 2.

When the input module is locked to a GPS signal, the filtering function ensures that the reference synchronisation signal fulfils ITU-T recommendation G.811⁶.

Table 2: Source: ITU-T recommendation G.812 (06/98).

	G.811	G.812					
		Type I	Type II	Type III	Type IV	Annex I	
						Type V	Type VI
Holdover	NA	2×10^{-10}	1×10^{-10}	1×10^{-9}	4×10^{-8}	1×10^{-9}	2×10^{-8}
Accuracy	1×10^{-11}	NA	1.6×10^{-8}	4.6×10^{-6}	4.6×10^{-6}	NA	NA
Period T	Lifetime	NA	1 year	1 year	1 year	NA	NA
Pull-in	NA	1×10^{-8}	1.6×10^{-8}	4.6×10^{-6}	4.6×10^{-6}	ND	ND
Hold-in	NA	NA	1.6×10^{-8}	4.6×10^{-6}	4.6×10^{-6}	ND	ND
Pull-out	NA	TBD	NA	NA	NA	ND	ND
GPS Module	GPS-x1-A/		GPS-x1-A				
	GPS-x1-B/	GPS-x1-B				GPS-x1-B	GPS-x1-B
				(GPS-x1-C) ⁸	(GPS-x1-C) ⁸		
NA Not Applicable TBD To Be Decided ND Not Decided NOTE – The time period T applies after 30 days of continuous synchronised operation.							

By using an internal oscillator (OSA 8663 OCXO or Rubidium), the OSA 5581C GPS-SR fulfils the above requirement for Synchronisation Supply Units (SSU) in an SDH or SONET network.

⁵ Revertive: if a valid input with higher priority than the current reference returns, the equipment will select the higher priority input as its primary reference input.

⁶ Please note that the U.S. DoD (Department of Defence) has set the SA (Selective Availability) to OFF as from May 1st, 2000. At the same time the maintenance of the GPS was transferred to DoT (Department of Transport).

In order to ensure that potential adversaries do not use GPS, the U.S. military is dedicated to the development and deployment of regional denial capabilities in lieu of global degradation.

⁷ When locked to GPS signal.

⁸ GPS-x1-C: Stipulated input module with OSA OCXO 8741 Fulfilling ITU-T G.812 (III & IV). Please contact your local representative or Oscilloquartz directly, for further detail and release plan.

 OSCILLOQUARTZ	Author: SIPA	Pages: 12 of 35
	Title: Booklet	File: b81c_13.doc
	Distribution: External	Reference: Rev 13 31/03/2003 SIPA

4.1.3 Oscillators

The input unit can contain one of two different oscillators, depending on the expected performance of the system. The different oscillators are:

4.1.3.1 OSA 8663 OCXO

The performance of the OSA 8663 OCXO meets or exceeds ITU-T G.812 type I, V & VI.

The long-term holdover stability⁹ of the OSA 8663 OCXO is:

- $< \pm 1 \times 10^{-10} / \text{day}$
- $< \pm 2 \times 10^{-8} / \text{year}$

Expected lifetime for the OSA 8663 OCXO is more than 15 years. It is totally maintenance-free and does not require any kind of mechanical adjustment.

4.1.3.2 OSA Rubidium oscillator

The performance of the OSA Rubidium oscillator meets or exceeds ITU-T G.812 type II.

The long-term holdover stability¹⁰ of the OSA Rubidium oscillator is:

- $< \pm 5 \times 10^{-11} / \text{month}$
- $< \pm 5 \times 10^{-10} / \text{year}$

The frequency stability is:

- $< 5 \times 10^{-10} / \text{day peak-to-peak } (-5^{\circ}\text{C} - +55^{\circ}\text{C})$

Expected lifetime for the OSA Rubidium oscillator is more than 7 years. It is totally maintenance-free and does not require any kind of mechanical adjustment.

4.1.4 GPS antenna system

The GPS module kit for the OSA 5581C GPS-SR is delivered with a standard antenna with mounting accessories, EMP protection kit and 10m interconnection cable (between antenna and EMP protection).

The remaining antenna cable (between EMP protection and equipment) has to be ordered separately. The antenna cable is available in length of 20m (RG58), 60m (RG213), and 120m (2 × RG213 [60m] with line amplifier). For lengths longer than 120 meters Oscilloquartz proposes the CellFlex cable, which can be ordered in exact lengths up to 300 meters.

Please contact Oscilloquartz if other requirements exist.

Figure 4 shows the principle for the GPS antenna installation.

⁹ Typical values after 30 days of continuous operation.

¹⁰ Typical values after 60 days of continuous operation.

 OSCILLOQUARTZ	Author: SIPA	Pages: 13 of 35
	Title: Booklet	File: b81c_13.doc
	Distribution: External	Reference: Rev 13 31/03/2003 SIPA

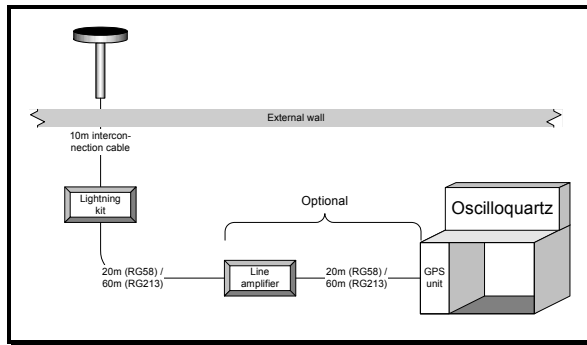

Figure 4: GPS antenna installation diagram.

4.2 Phase Stepper Switch

The Phase Stepper Switch (PSS) keeps the output signal from the standby GPS module in phase with that of the active GPS module.

4.2.1 Phase build-out

When the equipment changes reference, it will go into holdover for a short period of time (2 seconds) in order to provide a constant synchronisation signal to the output units.

Although the two inputs from the two GPS modules have the same frequency, they still can vary in phase [ϕ] (as shown in Figure 5). The result would be that, when switching between the two inputs, the synchronisation output would be affected by a phase jump, as shown in the figure (dotted line).

In the OSA 5581C GPS-SR Oscilloquartz has eliminated this phase jump by adjusting the phase of the “new” reference signal during an extended holdover period (additional 20 seconds). During this period, the element calculates a phase build-out constant that is used to align the phase of the reference with the phase of the internal holdover oscillator (as shown in Figure 5).

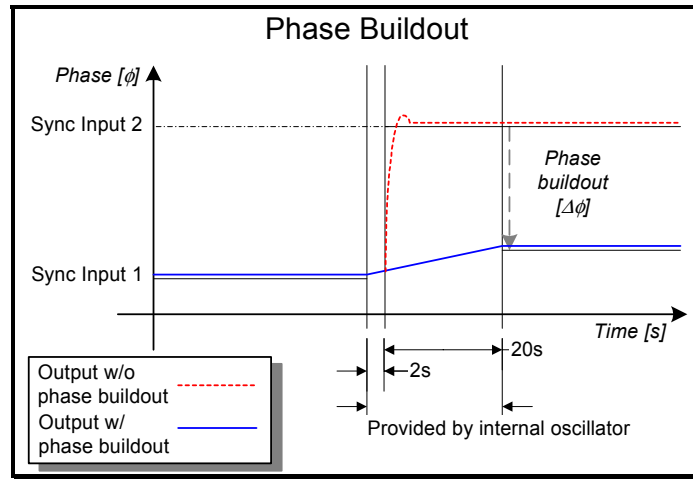

Figure 5: Schematic presentation of the phase buildout.

4.3 Synchronisation outputs

The OSA 5581C GPS-SR can be equipped with up to four Output Interface Units (OIUs) each providing 16 synchronisation output signals. Hence the OSA 5581C GPS-SR provides the following capacity of protected and unprotected outputs¹¹:

- 32 1+1 protected outputs (requires 4 OIUs)
- 16 1+1 protected and 32 unprotected outputs (requires 4 OIUs)
- 48 unprotected outputs (requires only 3 OIUs)¹²

The OSA 5581C GPS-SR can of course be equipped with only one or two OIUs, if fewer outputs are needed.

All outputs from the OSA 5581C GPS-SR can be individually squelched by operator commands via the management software. The default condition is for all outputs to be active.

The OSA 5581C GPS-SR also supports conditional squelching where the operator can set the condition under which the outputs are squelched.

Conditional squelching is possible for the following conditions:

- During the warm-up phase
(configurable squelching period)
- After a configurable delay after entering holdover mode
(configurable period before and after squelch)

When SSM mode is enabled, the OSA 5581C GPS provides SSM information on its E1/T1 outputs according to ITU-T G.781 specification. This information consists of the SSM value of the currently selected input or, if the equipment is in holdover, the SSM value corresponding to the holdover quality of the fitted oscillator.

¹¹ RTU modules can not be used in protected mode.

¹² In this configuration, the 4th OIU can not be used due to physical constrains in the connector area

 OSCILLOQUARTZ	Author: SIPA	Pages: 15 of 35
	Title: Booklet	File: b81c_13.doc
	Distribution: External	Reference: Rev 13 31/03/2003 SIPA

4.4 Re-Timing Unit (RTU)

A Re-Timing Unit (RTU) synchronises a traffic signal based upon the synchronisation signal from the OSA 5581C GPS-SR. Each channel in the RTU has a re-timing buffer holding two traffic frames. Each RTU provides retiming of up to 8 channels.

If the re-timing buffer overflows, controlled slips are applied to the traffic signals. Slips caused in the internal buffer can be monitored by suitably configuring alarm thresholds via the Local Manager or the SyncView™ Management software. Slip thresholds can be set in terms of slips per hour, day or week on an individual channel basis.

The RTU takes up one of the slots utilised for an Output Interface Unit.

Important: To ensure that traffic is not lost due to RTU card removal, card fault or loss of power in the equipment, the traffic signals are passed through the by-pass relays situated in the RTU connector tile set.

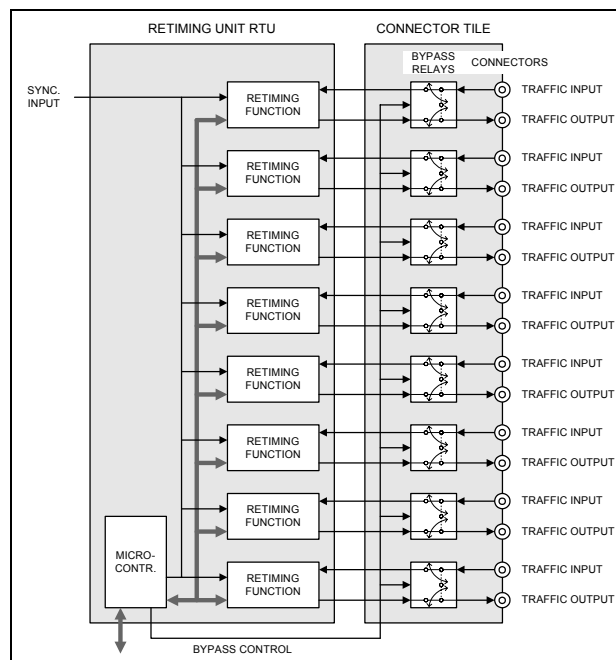



Figure 6: Block diagram of the Re-Timing Unit.

4.5 Output Connectors

Several output connector types are available. Output impedance can be either unbalanced (75Ω) or balanced (100Ω for T1 outputs, 133Ω for 64kbit/s cc outputs, 120Ω for all other output types). Field-exchangeable Output Connector Tiles determine the output connector type and output impedance.

RTU cards require specially designed connector tiles, which includes by-pass relays in case of unit failure.

 OSCILLOQUARTZ	Author:	SIPA	Pages:	16 of 35
	Title:	Booklet	File:	b81c_13.doc
	Distribution:	External	Reference:	Rev 13 31/03/2003 SIPA

4.6 Time Code Units (TCU)

4.6.1 Embedded NTP Server

The TCU-NTP module provides an embedded NTP (Network Time Protocol) Stratum 1 server functionality without having to provision and maintain a separate GPS receiver with antenna, cabling and management connection. Moreover, time information is kept even in case of loss of the GPS signal, that is, when the system is locked on an auxiliary input or when it is in holdover, with the accuracy of the active reference.

4.6.2 IRIG-B Outputs

The TCU-IRIG-B module provides four IRIG-B outputs as follows:

- 2 x IRIG-B code 122 (AM 1kHz)
- 2 x IRIG-B code 012 (ACMOS, pulse width coded)

Similarly to the TCU-NTP module, time information is kept even in case of loss of the GPS signal, that is, when the system is locked on an auxiliary input or when it is in holdover, with the accuracy of the active reference.

4.7 Management unit (MAC / RMU / LMU) and connection

The management unit (Monitoring and Alarms Controller [MAC], Remote Manager Unit [RMU] or Local Management Unit [LMU]) concentrates the alarms from all modules within the OSA 5581C GPS-SR and provides management connection(s) to the equipment. These units provide front panel LED indications, relay contact outputs for in-station monitoring, and an RS-232C port for external control using the Local Manager (LM for 5581C) software. LM software provides an user-friendly, graphical interface running on any IBM compatible computer equipped with MS Windows 98 / NT / 2000 / XP operating system. RMU additionally provides a connection to the SyncView™ synchronisation management system via a TCP/IP connection.

It is worth mentioning that failure or removal of the management unit will eliminate only the management functions provided by the unit itself, without affecting synchronisation in any way. For example, protection switching and input selection processes will still be ensured, as well as all the selected synchronisation outputs will still be active, with the same quality as before.

4.7.1 Remote Monitoring via Modem

The OSA 5581C GPS-SR can be supervised/managed in three different manners, using either the MAC, LMU or RMU management unit:

- Locally using LM for 5581C (MAC, LMU and RMU)
- Remotely using LM for 5581C and RAM (MAC, LMU and RMU)
This solution connects the LM to the management unit via a dial-up connection provided via telephone line or a LAN / WAN.
(Please refer to the RAM data sheet for more information on this solution)

 OSCILLOQUARTZ	Author:	SIPA	Pages:	17 of 35
	Title:	Booklet	File:	b81c_13.doc
	Distribution:	External	Reference:	Rev 13 31/03/2003 SIPA

- Remotely using SyncView™ (RMU only)
The OSA 5581C GPS-SR can be managed from SyncView™, the Synchronisation Management System from Oscilloquartz through a TCP/IP network using the RMU management unit.
(Please refer to the SyncView™ Booklet for further details)

4.8 Power Supply

The Power Supply Units (PSUs) 1 and 2 operate in a 1:1 hot standby protection mode. Failure or removal of one PSU has no effect on the synchronisation outputs of the OSA 5581C GPS-SR.

The OSA 5581C GPS-SR accepts 48VDC, 115VAC, or 220VAC in any combination.

4.9 Cover Plates

All non-equipped slots in the OSA 5581C GPS-SR must be fitted with cover plates for mechanical protection and for compliance with the relevant EMC and safety norms.

4.10 Configuration

All plug-in modules in the OSA 5581C GPS-SR are hot-pluggable i.e. can be replaced while the equipment is in use. The passive splitters and combiners are permanently fixed to the back plane for maximum security.

The table below shows an example of minimal configuration of the OSA 5581C GPS-SR.

Table 3: Minimal configuration of the OSA 5581C GPS-SR.

Quantity	Module
1	GPS-x1-Y (GPS input & holdover module)
1	PSS Bypass
1	OIU
1	OIU connectors Tile Set
1	PSU
1	PSU connector set
1	LMU
N	Cover plates to fill empty card and connector tile slots ¹³

4.11 Passive Timing Extractor (TEX-P)

Signals from non-terminated E1 / T1 links can be connected to the OSA 5581C GPS-SR using an external TEX-P. The TEX-P is a passive in-line device, normally mounted externally to the equipment, that taps off a

¹³ Needed for EMC and safety reason.

 OSCILLOQUARTZ	Author: SIPA	Pages: 18 of 35
	Title: Booklet	File: b81c_13.doc
	Distribution: External	Reference: Rev 13 31/03/2003 SIPA

portion of the digital signal without interfering with traffic or degrading the link in any way. One TEX-P handles up to two separate E1 / T1 feeds.

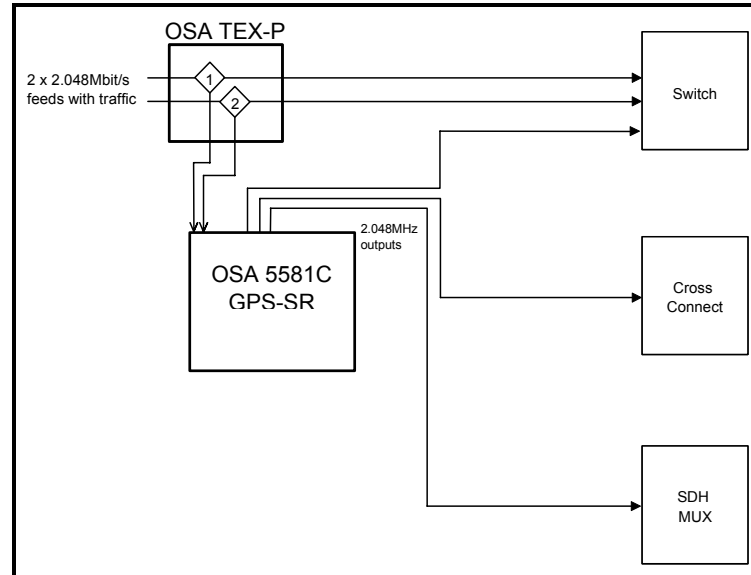



Figure 7: Typical use of the TEX-P with the OSA 5581C GPS-SR.

4.12 Impedance Adapter

Oscilloquartz supplies two kind of adapters, which both can be fitted to the equipment connectors.

- Impedance matching between 120Ω and 75Ω (Balun),
- Impedance matching between 75Ω and 50Ω.

Please refer to sections 7 for further details.

 OSCILLOQUARTZ	Author: SIPA	Pages: 19 of 35
	Title: Booklet	File: b81c_13.doc
	Distribution: External	Reference: Rev 13 31/03/2003 SIPA

5 Reliability

5.1 Method

The MTBF figures given in Table 4 were calculated according to MIL HDBK 217F1.0. The MTBF and availability values for the complete equipment were derived from these MTBF figures of the Table and the following assumptions:

- The failure rates λ_i of the modules is constant.
- MTTR is independent of time and of the number of modules to be repaired, its value is 3 days.
- The availability is constant (stationary condition).
- There is no down-time during repair of redundant modules.

The MTBF values of the complete equipment reflect the mean time between failures of the synchronisation function, i.e. the function of receiving and selecting an input reference, regenerating it or generating a local frequency in case of holdover mode, and distributing the output synchronisation signal to the equipment's outputs. The MTBF is calculated for the total failure of this synchronisation function. However, the system MTBF value does not account for failures of the equipment management function, since the latter has no influence on the integrity of the synchronisation function.

5.2 Reference Configuration

The calculations of MTBF and availability are based on the following reference configuration:

- 2×GPS-E1-B in hot redundancy
- 2×PSS
- 2×OIU-6 in hot redundancy
- 2×PSU-48VDC in hot redundancy

The reliability diagram of the reference configuration is given in Figure 8. In this diagram, the availability of the two input signals is assumed to be equal to 1. Protection of the OIUs can be obtained in two ways:

- Use an OIU pair in protected operating mode
- Use two unprotected OIUs and combine the two unprotected signals in the equipment they are connected to.

Table 4: MTBF figures of individual modules

Module	MTBF [h]	Module	MTBF [h]
GPS-E1-A (incl. antenna)	134,300	GPS-E1-B (incl. antenna)	134,300
GPS-T1-A (incl. antenna)	134,300	GPS-T1-B (incl. antenna)	134,300
PSS	96,000	PSS-Bypass	15,000,000
OIU-CC	45,000	RTU-T1	183,600
OIU-2	86,000	RTU-E1	183,600
OIU-6	86,000	PSU-115VAC	359,500
OIU-10	90,000	PSU-230VAC	398,400
OIU-5 MHz	90,000	PSU-48VDC	398,400
OIU-10 MHz	90,000	MACR-2	114,000
TEX-P	10,320,000	RMU	114,000
		Combiner/Splitter ¹⁴	15,000,000

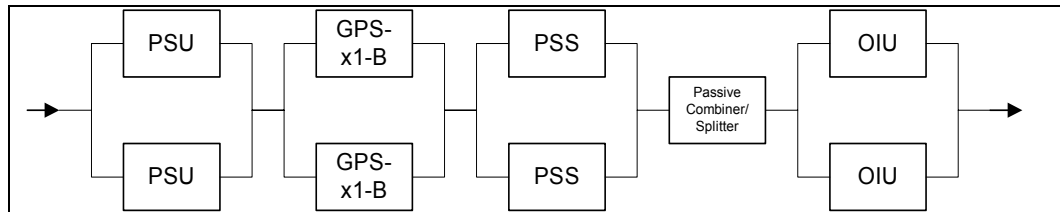

Figure 8: Reliability diagram of the reference configuration.

5.3 Reliability Calculations

$$MTTR = 3days = 72hours$$

$$\mu = \frac{1}{MTTR}$$

$$\lambda_i = \frac{1}{MTBF_i}, \quad \text{For } i = \text{GPS, PSS, OIU, PSU, and CS}^{15}$$

$$\lambda_1 = 2 \times \frac{(\lambda_{GPS})^2}{\mu} \quad \lambda_2 = 2 \times \frac{(\lambda_{PSS})^2}{\mu}$$

¹⁴ Passive component on the wiring backplane

¹⁵ CS = Combiner / Splitter

GPS = GPS Module GPS-x1-Y

PSS = Phase Stepper Switch

PSU = Power Supply Unit

OIU = Output Interface Unit

 OSCILLOQUARTZ	Author:	SIPA	Pages:	21 of 35
	Title:	Booklet	File:	b81c_13.doc
	Distribution:	External	Reference:	Rev 13 31/03/2003 SIPA

$$\lambda_3 = 2 \times \frac{(\lambda_{OIU})^2}{\mu} \qquad \lambda_4 = 2 \times \frac{(\lambda_{PSU})^2}{\mu}$$

$$MTBF = \frac{1}{\lambda_1 + \lambda_2 + \lambda_3 + \lambda_4 + \lambda_{CS}}$$

$$Availability = \frac{MTBF}{MTBF + MTTR}$$

Results:

MTBF = 9,225,300 hours = 1,037 years

Availability = 0.999992

 OSCILLOQUARTZ	Author: SIPA	Pages: 22 of 35
	Title: Booklet	File: b81c_13.doc
	Distribution: External	Reference: Rev 13 31/03/2003 SIPA

6 Technical data

All values are given at +25°C unless otherwise stated

6.1 Input / Hold-Over section¹⁶

Table 5: Technical data for the input and Hold-over section.

INPUT INTERFACE UNITS (Auxiliary inputs compiles to relevant sections in ITU-T G.703 & G.704)	
Input Characteristics¹⁷	<ul style="list-style-type: none"> • GPS signal, <ul style="list-style-type: none"> • L1 1575.42 MHz • External gain 11dB to 33 dB • Simultaneous tracking of up to 8 satellites • Electrical, <ul style="list-style-type: none"> • <i>GPS-E1-B</i>: 2.048Mbit/s (E1), HDB3 coded; 75Ω unbalanced (120Ω balanced via TEX-P or Balun) • <i>GPS-T1-B</i>: 1.544Mbps (T1) 75Ω unbalanced (100Ω balanced via TEX-P or Balun) • Frequency <ul style="list-style-type: none"> • Input: 64kHz, 1, 1.544, 2.048, 5, or 10MHz. • Automatic detection of input frequency • Sine wave input level: 0.3 to 1.5Vrms • Square wave input level: 1 to 5Vpp • 75Ω (120Ω via external Balun - not included) • SSM values <ul style="list-style-type: none"> • Extracted from incoming 2.048 Mbit/s (E1) and 1.544 Mbit/s (T1) input signals as per ITU-T G.781 recommendation • A static SSM value can be assigned via management software to every input signal that does not carry SSM information • Valid (i.e. locked) GPS inputs are assigned a PRC/PRS SSM quality
Input Qualification	Detection of the following criteria causes input changeover: For GPS-E1-B input module: LOS, LFA, AIS, ER For GPS-T1-B input module: LOS, COFA, AIS (Blue Alarm).
INPUT SELECTION	
Input Validation	Input validation criteria depend on input signal type. See section on Input Interface Units - Input Qualification.
Input Selection	Three possible input selection modes exist: <ul style="list-style-type: none"> • Automatic, based on user-defined priority table • Automatic, based on SSM and user-defined priority table • Manual
Max. Output Phase Change after Input Changeover	Phase build-out function cancels phase offsets between inputs. Output phase change: typically < 10ns; exact value depends on environmental conditions.

¹⁶ The OSA 5581C GPS-SR accepts one or two Holdover sections/GPS modules.

¹⁷ Unterminated E1/T1 input requires externally mounted TEX-P

 OSCILLOQUARTZ	Author: SIPA	Pages: 23 of 35
	Title: Booklet	File: b81c_13.doc
	Distribution: External	Reference: Rev 13 31/03/2003 SIPA

TRACKING SUBSYSTEM													
Type	Digital Phase Locked Loop (D-PLL). Incorporated in the GPS-x1-Y Input Interface Unit (IIU). Exceeds ITU-T G.812 Type I, II, V, and VI.												
Jitter & Wander Filtering Characteristics	Filter bandwidth: 20μHz to 20mHz, user programmable via the management software. Gain peaking: ≤ 0.2dB												
Loop Time Constant (τ)	Variable between 100 and 100,000 seconds (corresponds to filter bandwidth between 20μHz and 20mHz) to optimise filtering characteristics; programmable via the management software. Optimal value for GPS-x1-Y input module: 2'000s												
Noise Generation (Ideal input signal, or GPS locked, constant temperature)	<table border="0"> <tr> <td><u>Observation Period:</u></td> <td><u>TDEV:</u></td> </tr> <tr> <td>0.1s < τ ≤ 100s</td> <td>3 ns</td> </tr> <tr> <td>100s < τ ≤ 1'000s</td> <td>0.03 * τ ns</td> </tr> <tr> <td>1'000s < τ ≤ 10'000s</td> <td>30 ns</td> </tr> </table>	<u>Observation Period:</u>	<u>TDEV:</u>	0.1s < τ ≤ 100s	3 ns	100s < τ ≤ 1'000s	0.03 * τ ns	1'000s < τ ≤ 10'000s	30 ns				
	<u>Observation Period:</u>	<u>TDEV:</u>											
0.1s < τ ≤ 100s	3 ns												
100s < τ ≤ 1'000s	0.03 * τ ns												
1'000s < τ ≤ 10'000s	30 ns												
	<table border="0"> <tr> <td><u>Observation Period:</u></td> <td><u>MTIE:</u></td> </tr> <tr> <td>0.1s < τ ≤ 1'000s</td> <td>0.275 × 10⁻³ τ + 0.025μs</td> </tr> <tr> <td>1'000s < τ</td> <td>1 × 10⁻⁵ τ + 0.29μs</td> </tr> </table>	<u>Observation Period:</u>	<u>MTIE:</u>	0.1s < τ ≤ 1'000s	0.275 × 10 ⁻³ τ + 0.025μs	1'000s < τ	1 × 10 ⁻⁵ τ + 0.29μs						
<u>Observation Period:</u>	<u>MTIE:</u>												
0.1s < τ ≤ 1'000s	0.275 × 10 ⁻³ τ + 0.025μs												
1'000s < τ	1 × 10 ⁻⁵ τ + 0.29μs												
HOLDOVER OSCILLATOR¹⁸ (OCXO 8663 B6SG)													
Frequency Stability	< ±2.0 × 10 ⁻¹² /day (when locked to GPS)												
Holdover Stability (at 25°C)	< ±1.0 × 10 ⁻¹⁰ /day*												
	< ±2.0 × 10 ⁻⁸ /year *After 30 days of continuous operation												
Stability vs. Temperature	< ±6.0 × 10 ⁻¹⁰ pp (-5°C to +55°C)												
Initial Frequency Offset at Entry into Holdover Mode	< 1.5 × 10 ⁻¹¹												
Short Term Stability (Bw=1kHz)	< 1.5 × 10 ⁻¹¹ (0.2s – 10s)												
Pulling Range (peak to peak)	> 6 × 10 ⁻⁷												
Noise Generation (when in Hold-over mode, constant temperature)	<table border="0"> <tr> <td><u>Observation Period:</u></td> <td><u>TDEV (ns):</u></td> </tr> <tr> <td>0.1s < τ ≤ 25s</td> <td>3</td> </tr> <tr> <td>25s < τ ≤ 100 s</td> <td>0.12 * τ</td> </tr> <tr> <td>100s < τ ≤ 10'000 s</td> <td>12</td> </tr> </table>	<u>Observation Period:</u>	<u>TDEV (ns):</u>	0.1s < τ ≤ 25s	3	25s < τ ≤ 100 s	0.12 * τ	100s < τ ≤ 10'000 s	12				
	<u>Observation Period:</u>	<u>TDEV (ns):</u>											
0.1s < τ ≤ 25s	3												
25s < τ ≤ 100 s	0.12 * τ												
100s < τ ≤ 10'000 s	12												
	<table border="0"> <tr> <td><u>Observation Period:</u></td> <td><u>MTIE (μs):</u></td> </tr> <tr> <td>0.1s < τ ≤ 7.5s</td> <td>0.75</td> </tr> <tr> <td>7.5s < τ ≤ 20s</td> <td>0.1 * τ</td> </tr> <tr> <td>20s < τ ≤ 400s</td> <td>2</td> </tr> <tr> <td>400s < τ ≤ 1'000s</td> <td>0.005 * τ</td> </tr> <tr> <td>1'000s < τ ≤ 10'000s</td> <td>5</td> </tr> </table>	<u>Observation Period:</u>	<u>MTIE (μs):</u>	0.1s < τ ≤ 7.5s	0.75	7.5s < τ ≤ 20s	0.1 * τ	20s < τ ≤ 400s	2	400s < τ ≤ 1'000s	0.005 * τ	1'000s < τ ≤ 10'000s	5
<u>Observation Period:</u>	<u>MTIE (μs):</u>												
0.1s < τ ≤ 7.5s	0.75												
7.5s < τ ≤ 20s	0.1 * τ												
20s < τ ≤ 400s	2												
400s < τ ≤ 1'000s	0.005 * τ												
1'000s < τ ≤ 10'000s	5												
In-service adjustments	None required												
Life time	> 15 years												

¹⁸ Please refer to Table 2, page 11, for compliance to ITU recommendations.

 OSCILLOQUARTZ	Author: SIPA	Pages: 24 of 35
	Title: Booklet	File: b81c_13.doc
	Distribution: External	Reference: Rev 13 31/03/2003 SIPA

HOLDOVER OSCILLATOR¹⁸ (Rubidium oscillator)											
Frequency Stability	< ±2.0 × 10 ⁻¹² /day (when locked to GPS)										
Holdover Stability (at 25°C)	< ±5.0 × 10 ⁻¹¹ / month** < ±5.0 × 10 ⁻¹⁰ / year ** after three months of continuous operation										
Stability vs. Temperature	< ±1.0 × 10 ⁻¹⁰ pp (-5°C - +55°C)										
Initial Frequency Offset at Entry into Holdover Mode	4.58 × 10 ⁻¹³ (theoretical value)										
Short Term Stability	3 × 10 ⁻¹¹ / 1 second 1 × 10 ⁻¹¹ / 10 second 3 × 10 ⁻¹² / 100 second										
Pulling Range (peak to peak)	> 3 × 10 ⁻⁸ (G.812 type I compliant)										
Noise Generation (when in Hold-over mode, constant temperature)	<table border="0"> <tr> <td><u>Observation Period:</u></td> <td><u>TDEV (ns):</u></td> </tr> <tr> <td>0.1s < τ ≤ 25s</td> <td>3.2 * τ^{-0.5}</td> </tr> <tr> <td>25s < τ ≤ 40 s</td> <td>2</td> </tr> <tr> <td>40s < τ ≤ 1'000 s</td> <td>0.32 * τ^{0.5}</td> </tr> <tr> <td>1'000s < τ</td> <td>10</td> </tr> </table>	<u>Observation Period:</u>	<u>TDEV (ns):</u>	0.1s < τ ≤ 25s	3.2 * τ ^{-0.5}	25s < τ ≤ 40 s	2	40s < τ ≤ 1'000 s	0.32 * τ ^{0.5}	1'000s < τ	10
	<u>Observation Period:</u>	<u>TDEV (ns):</u>									
	0.1s < τ ≤ 25s	3.2 * τ ^{-0.5}									
	25s < τ ≤ 40 s	2									
40s < τ ≤ 1'000 s	0.32 * τ ^{0.5}										
1'000s < τ	10										
<table border="0"> <tr> <td><u>Observation Period:</u></td> <td><u>MTIE (μs):</u></td> </tr> <tr> <td>0.05s < τ ≤ 280s</td> <td>0.3 + 0.002'5τ</td> </tr> <tr> <td>280s < τ</td> <td>0.997 + 0.000'01τ</td> </tr> </table>	<u>Observation Period:</u>	<u>MTIE (μs):</u>	0.05s < τ ≤ 280s	0.3 + 0.002'5τ	280s < τ	0.997 + 0.000'01τ					
<u>Observation Period:</u>	<u>MTIE (μs):</u>										
0.05s < τ ≤ 280s	0.3 + 0.002'5τ										
280s < τ	0.997 + 0.000'01τ										
In-service adjustments	None required										
Life time	> 7 years										

 OSCILLOQUARTZ	Author: SIPA	Pages: 25 of 35
	Title: Booklet	File: b81c_13.doc
	Distribution: External	Reference: Rev 13 31/03/2003 SIPA

6.2 Output section

Table 6: Technical data for the output section.

OUTPUT INTERFACE UNITS (OIUs) & RE-TIMING UNITS (RTUs) (OIU & RTU types compiles to relevant sections in ITU-T G.703 & G.704)	
Number of Slots	OSA 5581C GPS-SR accepts up to 4 Output Interface Units (OIU) or 3 Re-Timing Units (RTU). <ul style="list-style-type: none"> Each OIU provides 16 outputs. Each RTU provides re-timing of 8 traffic channels.
OIU Types	OIU-CC: 16 outputs 64kbit/s composite clock OIU-2: 16 outputs 1.544Mbit/s OIU-10: 16 outputs 2.048MHz OIU-6: 16 outputs 2.048Mbit/s OIU-5MHz: 16 outputs 5MHz OIU-10MHz: 16 outputs 10MHz
RTU Types	RTU-T1: 8 channels 1.544Mbit/s (T1) RTU-E1: 8 channels 2.048Mbit/s (E1)
Other OIU/RTU Types	Please contact factory for other OIU types.
1 PPS (Pulse-Per-Second) specifications	Frequency: 1 PPS Duration: 200ms Polarity: True Level/Impedance: AC MOS 2.5 Vpp / 39 ohms serial resistor Connector type: BNC
Connectors¹⁹	Unbalanced ports: BNC or BT 43 Balanced ports: 9 pins Sub-D type or BNO Selection determinant by OIU Connector Tiles
Output Squelching	Squelch mask: Outputs can be squelched via a squelch mask under operator control on a per output basis. Squelch mask is set via the management software. Conditional squelch can be configured for special situations. Conditional squelch is programmable for following conditions: <ul style="list-style-type: none"> During the warm-up phase After a configurable delay after entering holdover mode.

¹⁹ The output connector tiles that are specified at the time of order determine required impedance.

 OSCILLOQUARTZ	Author: SIPA	Pages: 26 of 35
	Title: Booklet	File: b81c_13.doc
	Distribution: External	Reference: Rev 13 31/03/2003 SIPA

6.3 Management section

Table 7: Technical data for the Management Section.

MONITORING & ALARMS CONTROLLER (MAC2-R)	
Local Terminal Port	RS-232C on 9 pins Sub-D type connector
Protocol	TTY.
Communications Parameters	9600 baud, 8 bits, 2 stop bits, parity: none.
Event Log	Non-volatile memory stores 128 events with date and time stamp on a FIFO (First in First Out) basis.
Status Reporting	Events & alarms are reported spontaneously to the RS-232C port, to be presented in the management software.
Shelf Inventory	Fully automatic inventory for all replaceable modules and the sub-rack itself.
Alarms	<p>LED indicators are provided on the front panels of all modules. The following summaries of shelf alarms are provided on MAC2-R front panel:</p> <ul style="list-style-type: none"> • General Alarm • Critical • Major • Minor • Warning • Urgent • Non-urgent • Receiving Attention (LED and toggle switch)
Electrical Outputs	8 relay contacts ($I_{max}=250mA$; $V_{max} = 50V$; $P_{max} = 3W$). Contacts available from a 25 pins Sub-D type connector.
Alarm Output Masks	Alarm masks settable for each alarm output via the management software.

 OSCILLOQUARTZ	Author: SIPA	Pages: 27 of 35
	Title: Booklet	File: b81c_13.doc
	Distribution: External	Reference: Rev 13 31/03/2003 SIPA

REMOTE MANAGER UNIT (RMU)	
Local management port	RS-232C on 9 pins Sub-D type connector
Protocol on Local mngt Port	MML Language on RS232C serial communication
Remote management port	Ethernet on RJ-45 type connector
Protocol on Remote mngt port	MML Language on TCP/IP protocol
Shelf inventory	Fully automatic inventory for all replaceable modules
Alarms	<p>LED indicators are provided on the front panels of all modules.</p> <p>The following summaries of shelf alarms are provided on RMU front panel:</p> <ul style="list-style-type: none"> General Alarm Critical Major Minor Warning Urgent Non-urgent Receiving Attention (LED and toggle switch)
Electrical Outputs	<p>8 relay contacts (Imax=250mA; Vmax = 50V; P max = 3W).</p> <p>Contacts available from a 25 pins Sub-D type connector.</p>
Alarm Output Masks	Alarm masks settable for alarms/events at display in the management software.
Status Reporting	Events & alarms are reported spontaneously to the LED and the local & remote management port to be presented in the management software.
Event Log	Non-volatile memory stores 128 events with date and time stamp on a FIFO (First in First Out) basis.

 OSCILLOQUARTZ	Author: SIPA	Pages: 28 of 35
	Title: Booklet	File: b81c_13.doc
	Distribution: External	Reference: Rev 13 31/03/2003 SIPA

6.4 Physical data

Table 8: Physical data for the OSA 5581C GPS-SR.

POWER SUPPLIES Unit (PSU)	
Configuration	Duplicated PSUs in 1+1 hot standby protection
Input Voltages	36 – 72 VDC floating input, or 65 – 132VAC, or 150 – 265VAC
Power Consumption (Max. value; actual values depend on configuration)	< 70W during Warm-up < 60W during steady state
Warm-up	~10 minutes before available outputs ~24 hours before full specification are obtained ²⁰
ENVIRONMENTAL	
Storage Temperature	According to ETS 300 019-2.1, Class 1.1
Transport Temperature	According to ETS 300 019-2.2, Class 2.2
Operating Temperature Range	According to ETS 300 019-2.3, Class 3.2
Humidity	5 – 95% non-condensing.
EMC & SAFETY - CE Mark	
EMC	Certified to EN50081-1 and EN50082-1 & EN50082-2 Susceptibility to IEC 801 parts 2, 3, 4, 5 and 6
Safety	Conforming to EN61010-1 and EN60950
MECHANICAL	
Mounting	ETSI ETS 300-119 300mm or 19" rack mount.
Size H×W×D	ETSI 6U: 266 x 535 x 240mm (10.47 x 21.06 x 9.45in.) 19" 3U: 133 x 483 x 270mm (5.24 x 19 x 10.63in.)
Connector Access	ETSI version: Front access 19" version: Rear access.
WEIGHT	
	~ 9kg (20 lbs) excluding cables & packing.

²⁰ Need at least four visual GPS satellites for the first 24 hours.

 OSCILLOQUARTZ	Author: SIPA	Pages: 29 of 35
	Title: Booklet	File: b81c_13.doc
	Distribution: External	Reference: Rev 13 31/03/2003 SIPA

6.5 External passive timing extraction unit (TEX-P)

Table 9: Technical data for the External Passive Timing Extraction Unit (TEX-P).

EXTERNAL PASSIVE TIMING EXTRACTION UNIT (TEX-P)	
Number of circuits	Two independent circuits
Attenuation between ports “Data line IN” & “Data line OUT”	$\leq 0.5\text{dB}$, $0.1 \leq f \leq 3\text{MHz}$
Attenuation between ports “Data line IN” & “Signal OUT”	$18\text{dB} \pm 1\text{dB}$, $0.1 \leq f \leq 3\text{MHz}$
Impedance of ports “Data line IN/OUT”	75Ω unbalanced or 120Ω balanced
Impedance of ports “Signal OUT”	75Ω unbalanced
Return loss of ports “Data line IN” (75Ω) & “Signal OUT”	$\leq -20\text{dB}$, $0.1 \leq f \leq 3\text{MHz}$
Connectors	Ports “Data line IN/OUT”: Solder Tags Ports “Signal OUT”: CEI 1.5/5.6 coax connectors.
Dimensions (H×W×D)	112×43.1×64.5mm (4.41×1.70×2.54in)

 OSCILLOQUARTZ	Author: SIPA	Pages: 30 of 35
	Title: Booklet	File: b81c_13.doc
	Distribution: External	Reference: Rev 13 31/03/2003 SIPA

7 Summary of OSA 5581C GPS-SR parts

Table 10: Summary of OSA 5581C GPS-SR parts.

Name
<i>Sub-rack</i>
ETSI/6U Mainframe for OSA 5581C, CE approved Delivered with: 1x Operating and Technical Manual on CD-ROM 1x Set of standard accessories, Packing included
19"/3U Mainframe for OSA 5581C, CE approved Delivered with: 1x Operating and Technical Manual on CD-ROM 1x Set of standard accessories, Packing included
<i>Input & Holdover Unit (width 12TE)</i>
GPS-E1-A Kit, including: <ul style="list-style-type: none"> • GPS-E1-A module with Rubidium Oscillator • Antenna • Lightning protection kit, including EMP protector Capsule • 10m interconnection cable
GPS-T1-A Kit, including: <ul style="list-style-type: none"> • GPS-T1-A module with Rubidium Oscillator • Antenna • Lightning protection kit, including EMP protector Capsule • 10m interconnection cable
GPS-E1-B Kit, including: <ul style="list-style-type: none"> • GPS-E1-B module with OCXO 8663 • Antenna • Lightning protection kit, including EMP protector Capsule • 10m interconnection cable
GPS-T1-B Kit, including: <ul style="list-style-type: none"> • GPS-T1-B module with OCXO 8663 • Antenna • Lightning protection kit, including EMP protector Capsule • 10m interconnection cable
<i>Phased Stepper Switch Section (width 4TE)</i>
PSS Bypass Board
PSS Phase Stepper Switch
<i>Output Interface Unit (width 4TE)</i>
OIU-CC 16 outputs 64Kbit/s c/c
OIU-2 16 outputs 1.544Mbit/s
OIU-6 16 outputs 2.048Mbit/s
OIU-10 16 outputs 2.048MHz

 OSCILLOQUARTZ	Author: SIPA	Pages: 31 of 35
	Title: Booklet	File: b81c_13.doc
	Distribution: External	Reference: Rev 13 31/03/2003 SIPA

OIU-1.544MHz 16 outputs 1.544MHz
OIU-5MHz, 16 outputs, 1Vrms
OIU-10MHz, 16 outputs, 1Vrms
<i>Output Interface Unit (width 4TE)</i>
OIU Connector Tile Set 16 x 50Ω/BNC connector
OIU Connector Tile Set 16 x 75Ω/BNC connector
OIU Connector Tile Set 16 x 75Ω /BT43
OIU Connector Tile Set 16 x 75Ω / CEI 1.0/2.3
OIU Connector Tile Set 16 x 75Ω / CEI 1.0/2.3 (only for 64 outputs)
OIU Connector Tile Set 16 x 75Ω / CEI 1.6/5.6
OIU Connector Tile Set 16 x 75Ω / CEI 1.6/5.6 (only for 64 outputs)
OIU Connector Tile Set 16 x 100Ω / BNO connector
OIU Connector Tile Set 16 x 100Ω, Balanced Sub-D, 9p two output per connector
OIU Connector Tile Set 16 x 120Ω Balanced/Sub-D, 9p two outputs per connector.
OIU Connector Tile Set 16 x 133Ω / BNO connector
<i>Re-Timing Unit (width 4TE)</i>
RTU-T1, 8 channels, 1.544Mbit/s
RTU-E1, 8 channels, 2.048Mbit/s
RTU Connector Tile Set for RTU-E1 75Ω, BNC, 8 channels in-out
RTU Connector Tile Set for RTU-T1 100Ω, Sub-D 9p, 8 channels in-out
RTU Connector Tile Set for RTU-E1 120Ω Balanced, Sub-D 9p, 8 channels in-out
<i>Time Code Module (width: 8TE)</i>
NTP, Time Code Unit
<i>Management Module (width: 4TE)</i>
MAC2-R Management Unit with Urgent/Non-Urgent Alarms RS 232 Interface and Relay outputs
MAC2-R (Option A) Management Unit with Urgent/Non-Urgent Alarms RS 232 Interface and Relay outputs inverted.
RMU Management Unit with Urgent/Non-Urgent Alarms RS 232 Interface and Relay outputs inverted. TCP/IP connection to SyncView [®]
RMU (Option A) Management Unit with Urgent/Non-Urgent Alarms RS 232 Interface and Relay outputs. TCP/IP connection to SyncView [®]
Local Manager for the OSA 5581C GPS-SR Software & User guide on CD-ROM for Windows 95/98/NT
<i>Power Supply Units (width: 12TE)</i>
Power Supply Unit DC/DC (36-72VDC), 75W
Power Supply Unit AC/DC (65 – 132VAC), 75W
Power Supply Unit AC/DC (150 – 265VAC), 75W
PSU Panel with 1×DC & 1×AC connectors
PSU Panel with 2× AC connectors
PSU Panel with 2×DC connectors
<i>Cover Plates</i>
Cover Plate 4TE
Cover Plate 8TE
Cover Plate 12TE
OIU/RTU Dummy Tiles (Set of 4x4TE tiles)
<i>Accessories</i>

 OSCILLOQUARTZ	Author:	SIPA	Pages:	32 of 35
	Title:	Booklet	File:	b81c_13.doc
	Distribution:	External	Reference:	Rev 13 31/03/2003 SIPA

Balun: 120Ω /75Ω with Krone Connector for 120Ω-end, BNC Connector for 75Ω-end
TEX-P, 2 Way Passive Timing Extractor (CEI 1.5/5.6)
Antenna for GPS-x1-B with mounting kit (without cable)
GPS-E1-B with OCXO 8663 (module only)
GPS-T1-B with OCXO 8663 (module only)
GPS CellFlex cable valid for lengths up to 300m. (order per 1m) Includes 2×terminating N-connectors Please specify exact length
GPS antenna cable – RG58 (20m)
GPS antenna cable – RG213 (60m)
GPS Line Amplifier (for cable length up to 60m + 60m)
GPS Lightning Protection Kit, including <ul style="list-style-type: none"> • EMP protector • Capsule
Surge Arrester Capsule
Accessory kit for 5581C
Operating Manual for 5581C ETSI, Printed
Technical Documentation on CD-ROM for OSA 5581C GPS-SR

 OSCILLOQUARTZ	Author: SIPA	Pages: 33 of 35
	Title: Booklet	File: b81c_13.doc
	Distribution: External	Reference: Rev 13 31/03/2003 SIPA

8 Glossary

Table 11: Abbreviation used in this document.

Abbreviation	Term	Definition
ANSI		American National Standards Institute
CRC	Cyclic Redundancy Check	A method to determine errors in data strings
CTO	Compact Tracking Oscillator	An Oscilloquartz name for a compact SASE
DS1		DS1 is an abbreviation for 1544 kbit/s signals
E1		E1 is an abbreviation for 2048 kbit/s signals
ETSI		European Telecommunication Standard Institute
GSM	Global System for Mobile communication	GSM is a digital mobile telephone system that is widely used in Europe and other parts of the world.
GPS	Global Positioning System	The GPS (Global Positioning System) is a "constellation" of 24 well-spaced satellites that orbit the Earth and make it possible for people with ground receivers to pinpoint their geographic location. The GPS is also widely used as an accurate synchronisation reference.
IIU	Input Interface Unit	
ITU-T		International Telecommunication Union - Telecommunication
MAC	Monitoring & Alarms Controller	Management interface module used in Oscilloquartz equipment
MRTIE	Maximum Relative TIE	
MSC		Mobile Switch Center
MUX	Multiplexer	
NE	Network Element	
OCXO	Oven Controlled Crystal Oscillator	e.g. OCXO 8741
OIU	Output Interface Unit	Term for Oscilloquartz' output interface module.
OSA	Oscilloquartz S.A.	
ppm	Parts per million	
PSS	Phase Stepper Switch	
PSU	Power Supply Unit	
QL	Quality Level	
SASE	Stand-Alone Synchronisation Equipment	A stand-alone implementation of the SSU function.
SDH	Synchronous Digital Hierarchy	A world standard transmission technology based on synchronous multiplexing
SDU	Synchronisation Distribution Unit	An output expansion shelf
SSM	Synchronisation Status Message	A coding of the reference quality level of the timing source as specified in G.707 & G.781.
SSU	Synchronisation Supply Unit	An equipment function for synchronisation reference selection, regeneration and distribution.

 OSCILLOQUARTZ	Author: SIPA	Pages: 34 of 35
	Title: Booklet	File: b81c_13.doc
	Distribution: External	Reference: Rev 13 31/03/2003 SIPA

SyncView™		SyncView is Oscilloquartz' network management system (NMS). SyncView offers you considerable savings by rationalising operation and maintenance tasks. It manages your entire Oscilloquartz synchronisation network from a single point and optionally enables control at regional level.
T1		Same as DS1: an abbreviation for 1544 kbit/s signals
TDEV	Time Deviation	
TEX-P	Passive Timing Extraction	Passive in-line device normally mounted external to the equipment, used to couple 1544 or 2048 kbit/s links to the equipment without terminating them.
TIE	Time Interval Error	Variation in time delay of a given timing signal with respect to an ideal timing signal over a particular time period. TIE is expressed as a function of the observation time <i>S</i> (seconds).
TMN	Telecommunications Management Network	
UMTS	Universal Mobile Telecommunications System	UMTS is a so-called "third-generation (3G)," broadband, packet-based transmission, offering a consistent set of services to mobile computer and phone users no matter where they are located in the world.

 OSCILLOQUARTZ	Author:	SIPA	Pages:	35 of 35
	Title:	Booklet	File:	b81c_13.doc
	Distribution:	External	Reference:	Rev 13 31/03/2003 SIPA

9 Document History

Table 12: Document history for this document.

Revision	Date	Author	Description
Rev. A	March 2000	THTH	First version
Rev. B	March 2000	THTH	Updated preface
Rev. C	March 2000	THTH	Updated this page
Rev. D	May 2000	THTH	Included oscillator data, updated SA data, included RTU connectors.
Rev. 05	Oct. 2000	THTH	Corrected "Noise generation data"
Rev. 06	Oct. 2000	THTH	Clarification of OCXO data, updated part numbers, included RAM
Rev. 07	Nov.2000	THTH	Various updates, e.g. the Part Numbers, inclusion of the FlexCell cable
Rev. 08	Jan. 2001	THTH	Updated part numbers
Rev. 09	May 2001	THTH	Combined all releases of the equipment
Rev. 10	June 2001	THTH	Corrected reference input modules in Table 2 and holdover data for Rb (§4.1.3.2. & §6.1.)
Rev. 11	August 2002	SIPA	Corrected environmental data (temperatures)
Rev. 12	Sep 2002	SIPA	Corrected holdover stability figures
Rev. 13	Mar 2003	SIPA	Removed pictures to reduce document size (5 to 1MB) Modified references to TCU-NTP Added references to TCU-IRIG-B Added descriptions of SSM functionality Removed references to Windows 95 Removed references to Bypass OIU and tile set Corrected SyncView™ into SyncView™ Corrected other minor mistakes

In accordance with the Oscilloquartz policy of continuous development and improvement, Oscilloquartz reserve the right to modify the design and specifications of our products, together with the content of all Oscilloquartz documentation, without prior notice